

HANCOCK COMMUNITIES

Canyon Trails

Planned Area Development Narrative Report

Southeast Corner of Van Buren St. and 173rd Ave.

Case # 19-210-00006

(Amendment to #18-210-000001 &
#19-210-00002)

Submitted: August 09, 2019

**Revised: October 22, 2019
December 6, 2019**

By:

Beus Gilbert McGroder PLLC

701 N. 44th Street, Phoenix, Arizona 85008

Andy Jochums, Planning Consultant

480-429-3063 -- ajochums@beusgilbert.com

Request

The subject property is located at the southeast corner of Van Buren Street and 173rd Avenue, adjacent to the Loop 303 Freeway, and generally consists of approximately 47 acres. The subject property is generally split between the “north” property consisting of 19.46 net acres which was zoned as part of Christopher Todd Communities at Canyon Trails PAD under case #18-210-000001 & amended to address a building height error under case #19-210-00002).

This amendment seeks to add a 27.11 acre “south” property to the PAD Zoning along with a name change of the expanded PAD. *(See Exhibit A, Aerial Vicinity Map and Exhibit B, Aerial Parcel Map)*

The Hancock Communities at Canyon Trails PAD (“Hancock at Canyon Trails”) seeks to remove the southern property from the Canyon Trails PAD and separately rezone it Final PAD as a stand-alone project pursuant to this document.

Property Overview

Adjacent to the site to the west across 173rd Avenue and along the southwest border are existing single family homes within the Canyon Trails project. *(See Exhibit D, Existing Zoning)* To the north across Van Buren Street is land currently owned by the State of Arizona, used for part of the interchange between the Loop 303 and Interstate 10 and to the east of the subject property is a Maricopa County Flood Control District (MCFCD) channel and the Loop 303 freeway.

Plan Conformance

The Goodyear 2025 General Plan designates the property with a Neighborhoods land use category as well with the Village Center Overlay. *(See Exhibit C, General Plan Land Use Plan)* Pursuant to the Land Use – Zoning Correlation list found on page 134 of the General Plan, the above category and overlay both allow multi-family zoning with a PAD.

A few of the Goals, Objectives, and Standards within the General Plan that support rezoning of the property for multi-family are listed below:

Goal GD-1 - Physical Growth and Development

A compatible mix of land uses and diverse destinations that foster a high quality of life with livable and safe neighborhoods with a strong economy that fosters a healthy and sustainable environment.

Goal CC-2 – Community and Cultural Development

A diverse stock of high quality housing that meets the needs of all residents.

Objective GD-1-1 – Land Use

Establish a land use hierarchy and community form that maintains a broad variety of land uses and responds to the community’s vision and needs.

Objective CC-1-1 – Neighborhoods

Create and foster complete neighborhoods.

Objective CC-1-3 – Neighborhoods

Foster the creation and maintenance of attractive, high quality neighborhoods.

Objective CC-2-1 – Housing

Provide diverse and quality housing products.

Policy B Promote higher residential densities near and within the City Center, along the McDowell Road/Interstate 10 commercial corridor, the future Loop 303 corridor south of I-10, and near transit stations.

Land Use and Transportation Plan Development Standards

Standard 1 - Universal Development Standards

All development proposals shall demonstrate their conformance with the applicable stated goals, objectives, and policies contained within the General Plan, and how the development furthers the appropriate implementation of the General Plan.

Standard 2 – Universal Development Standards

While Goodyear encourages quality development throughout the planning area, growth and redevelopment is highly encouraged to locate in areas with existing infrastructure and services, in the City's Redevelopment Area (see Figure 5.7), within walking distance of transit stations, and along existing interstate/freeways.

Standard 26 – Neighborhoods Category

Medium Density Residential. Residential uses with densities greater than 5 dwelling units per acre up to 12 dwelling units per acre, may be considered along arterial roads, adjacent to commercial areas, adjacent to community and regional parks or significant open space areas, adjacent to interstates when appropriately buffered, or to provide transition between low and high density residential uses.

Standard 53 – Village Center Overlay

Multi-family residential developments are appropriate in the Village Center Overlay. The development shall have strong ties to nearby commercial areas and ample pedestrian access.

Development Plan

Hancock at Canyon Trails is a unique multi-family development that allows each rental unit the benefits of having a privately enclosed backyard.

While multi-family in zoning, with multiple dwelling units on a single parcel, Hancock at Canyon Trails is a horizontal rental community and functions more like a grouping of attached and detached single-family buildings and is akin to a compact single family subdivision offering central amenities. Unlike the typical vertical apartment complexes that are two or more stories, horizontal communities are single story and in the case of Hancock at Canyon Trails, are luxurious homes that are for rent.

As depicted in the Conceptual Site Plan and Landscape Plans (*See Exhibits F and G*) buildings are grouped to create intimate courtyards, anchored by a shade tree to support healthy neighborhood interaction. There is a main communal area for recreation central to the development consisting of community swimming pool and spa, a covered ramada, and turf for recreation. Each unit offers a small private backyard, similar to a single-family home; however, this yard will be maintained by the site manager, just like the remainder of the property.

The southeastern border of Hancock at Canyon Trails is unique in that it is adjacent to an existing fence built as the perimeter to that single family detached community. As depicted on the Conceptual Site Plan, a second wall will not be added; therefore, this existing fence will also serve the multi-family community. Care will be made in grading the Hancock at Canyon Trails and every attempt will be made to match up the finished floors of the adjacent homes (both single family and multi-family) to preserve the rear yard privacy afforded by both residents.

Hancock at Canyon Trails will fill a niche market for those Goodyear renters who don't need the size of a single-family home or that don't want the maintenance that comes along with a yard, but also don't want the traditional apartment experience with a loud neighbor above or below them in a large building.

Permitted Uses

Primary and Accessory uses on the property shall be those permitted within the MF-18 district.

Development Standards

The traditional requirements of the City of Goodyear development standards for multi-family are not applicable to the unique residential product used in Hancock at Canyon Trails. As such, Hancock at Canyon Trails is proposing to use Development Standards from the MF-18 district as a base and modify only certain standards within this PAD. (*See Exhibit E, Final PAD Development Regulations*)

Justification for the modified standards is as follows:

Reduction in Building Setbacks

Reduced perimeter building setbacks have been requested on the Side (south) only. A 30' building setback would normally be required along this border; however, given that the base zoning district allows for two story structures and all the buildings of

Hancock at Canyon Trails are limited to single story, the reduction in setback to the requested 20' minimum would appear to pose no issues on the nearby properties.

Reduction in Perimeter Landscaping

The preliminary plan for Hancock at Canyon Trails includes 14 foot deep private rear yards along Van Buren and 15 foot deep yards along 173rd as well as 20 foot deep yards adjacent to the southern property line and 20 foot deep yards along the Loop 303 and MCFCD channel. In lieu of providing a separate perimeter landscape tract, which would normally be found in a multi-family apartment complex, we propose a reduced or eliminated perimeter landscape requirement in these areas as the rear yards, which include a tree serves a similar buffering purpose. These yards make the rental units function similar to that of a single-family residential lot, which would not require the aforementioned perimeter landscaping. Along the adjacent streets, landscape tract outside of the perimeter wall are still provided. Along Van Buren there is a 10' wide tract, and along 173rd Avenue, there is a 15' wide tract. When combined with landscaping in the right-of-way, and the trees in the adjacent rear yards, substantial vegetative buffering is provided along the adjacent streets along with trees to shade the sidewalks.

Reduction in Building Separation

Traditional multi-family zoning expects large buildings consisting of multiple units, thereby creating a large building mass. Hancock at Canyon Trails consists of one-story residential homes that are either fully detached (2 bedroom units consisting of 1,022 square feet under roof) or duplex style (1 bedroom units consisting of a total of 1,336 square feet under roof for the two unit building.) Wherein building separation is typically expected to maintain a 20' between building entrances and 15' between all other building faces, we are requesting a 10' minimum separation. Given the small building mass, this separation allows for a more pedestrian scale and provides an intimate experience in the walkways between the buildings.

Reduction in Density and Height

In support of the above requested reductions, Hancock at Canyon Trails is also proposing reductions in the allowed density and height for the property. The reduction in the maximum density from 18 du/ac to 14 du/ac as well as the limitation of maximum 1 story buildings (down from 30 feet allowed in the MF-18 Zoning District used as a base) strengthens the justification for the proposed reduced development standards for perimeter landscaping, building setback and building separation.

Design Guidelines

All development within the Hancock Communities at Canyon Trails PAD shall exhibit enhanced building elevations with a variety of materials and paint colors to avoid the look of sameness.

Architecture theme for the community shall be a mix of “Santa Barbara” and “Tuscan” (See *Exhibit E, Final PAD Development Regulations*) or two similar themes illustrating the same level of quality and detail as those included herein. A minimum of three color schemes shall be used for each theme to add variety and visual interest with exterior colors and materials specific to each color scheme. Each one-story residence will feature four-sided detailing including but not limited to masonry or stone, corbels, column details, and gable end detailing, appropriate for the architectural theme. The massing of the structures will include articulated facades, varying roof forms which will include tile covered roofs featuring hipped gables, Dutch gables, and dormers typical of the architecture style. Flat roofs will not be permitted.

Exhibit A
Aerial Vicinity Map

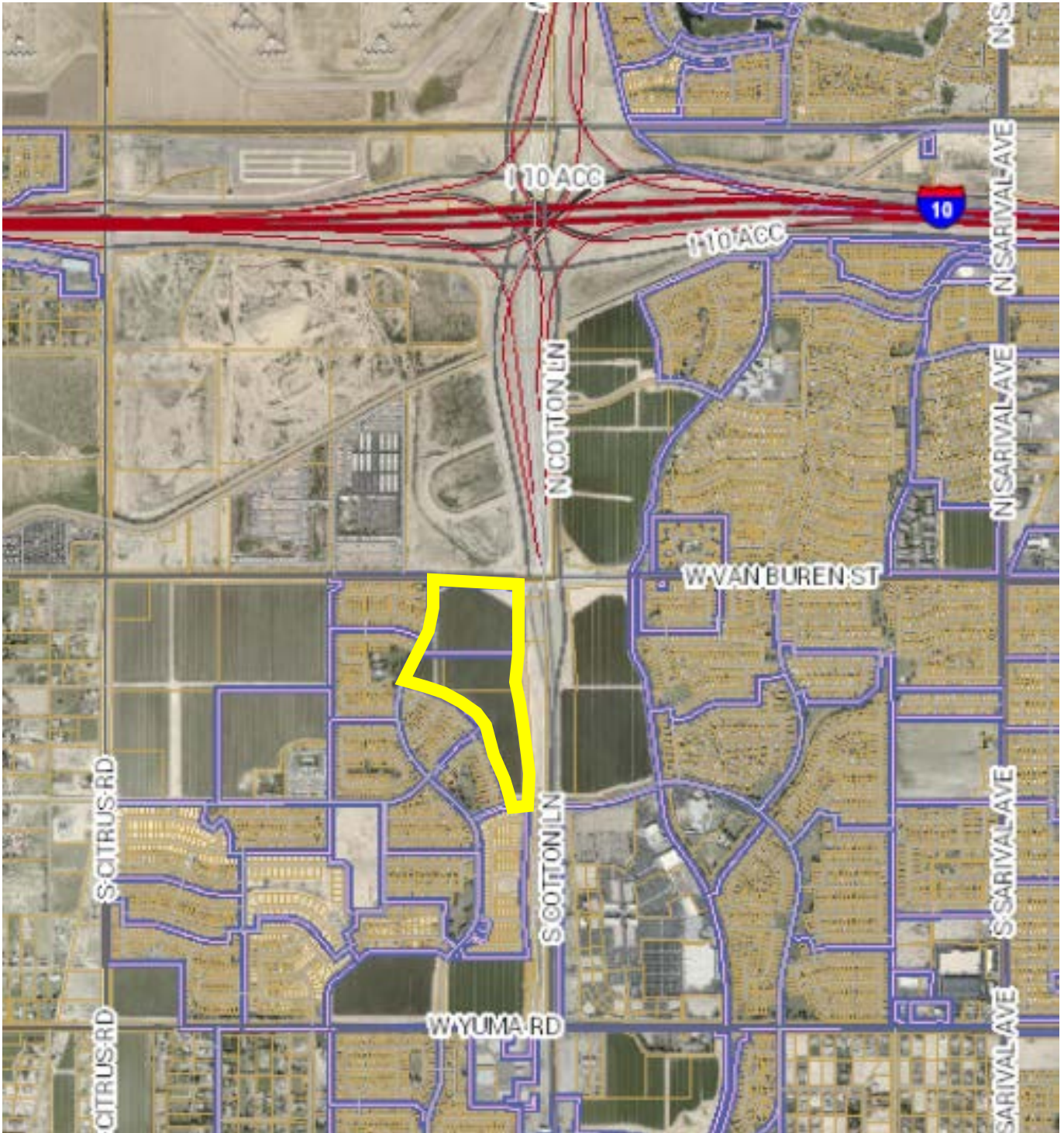

Exhibit B
Aerial Parcel Map

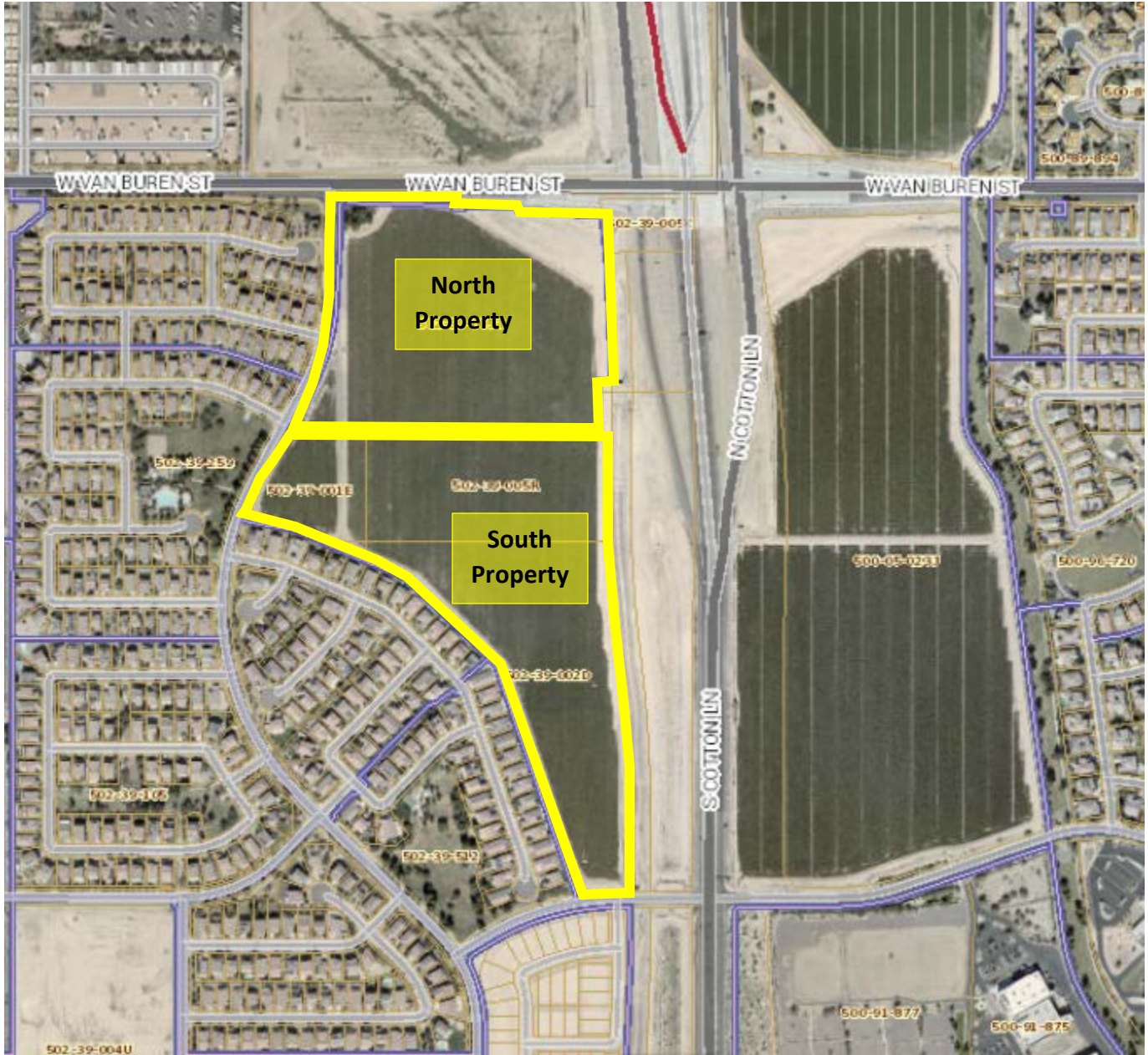

Exhibit C

General Plan Land Use Plan

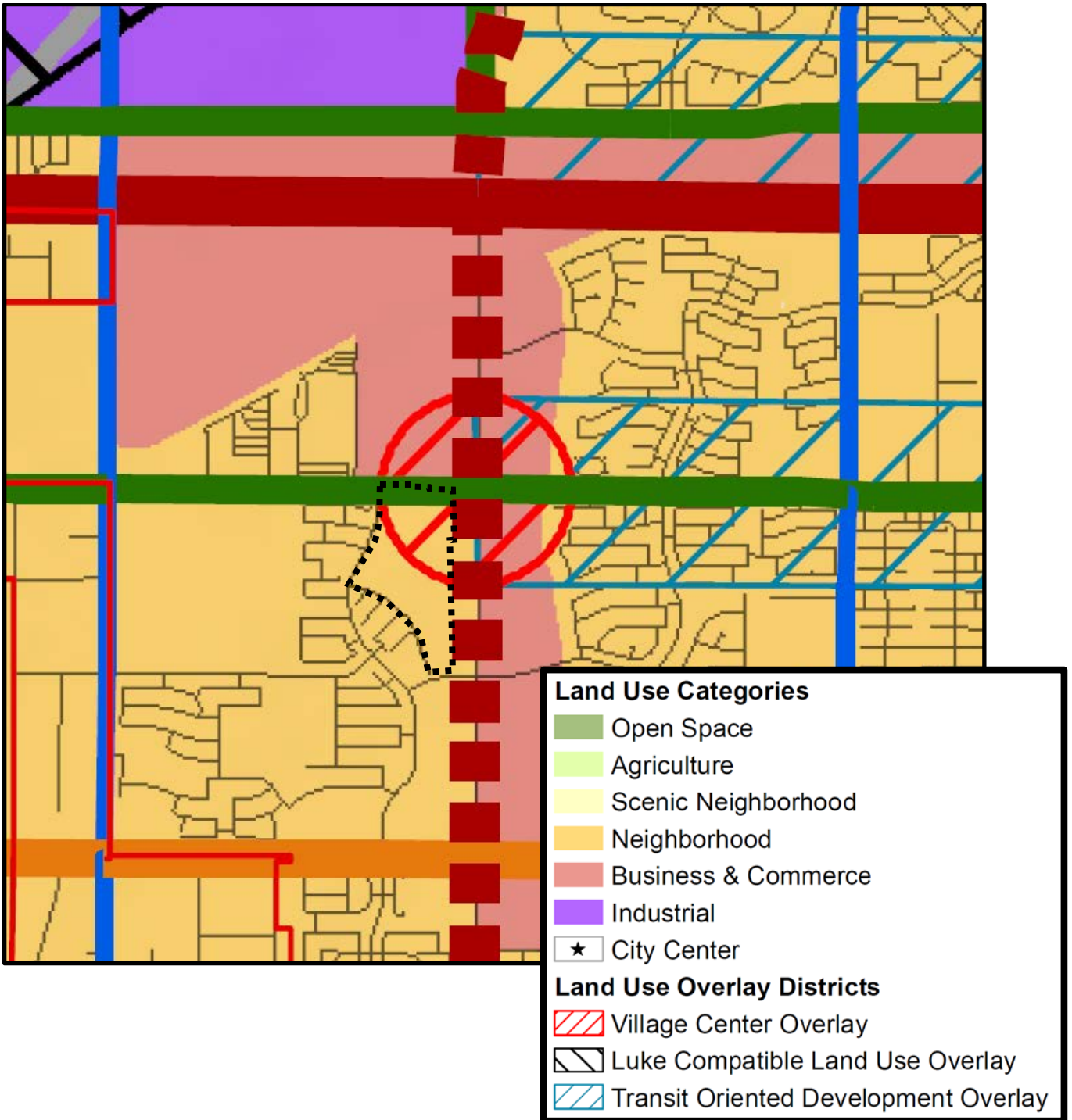
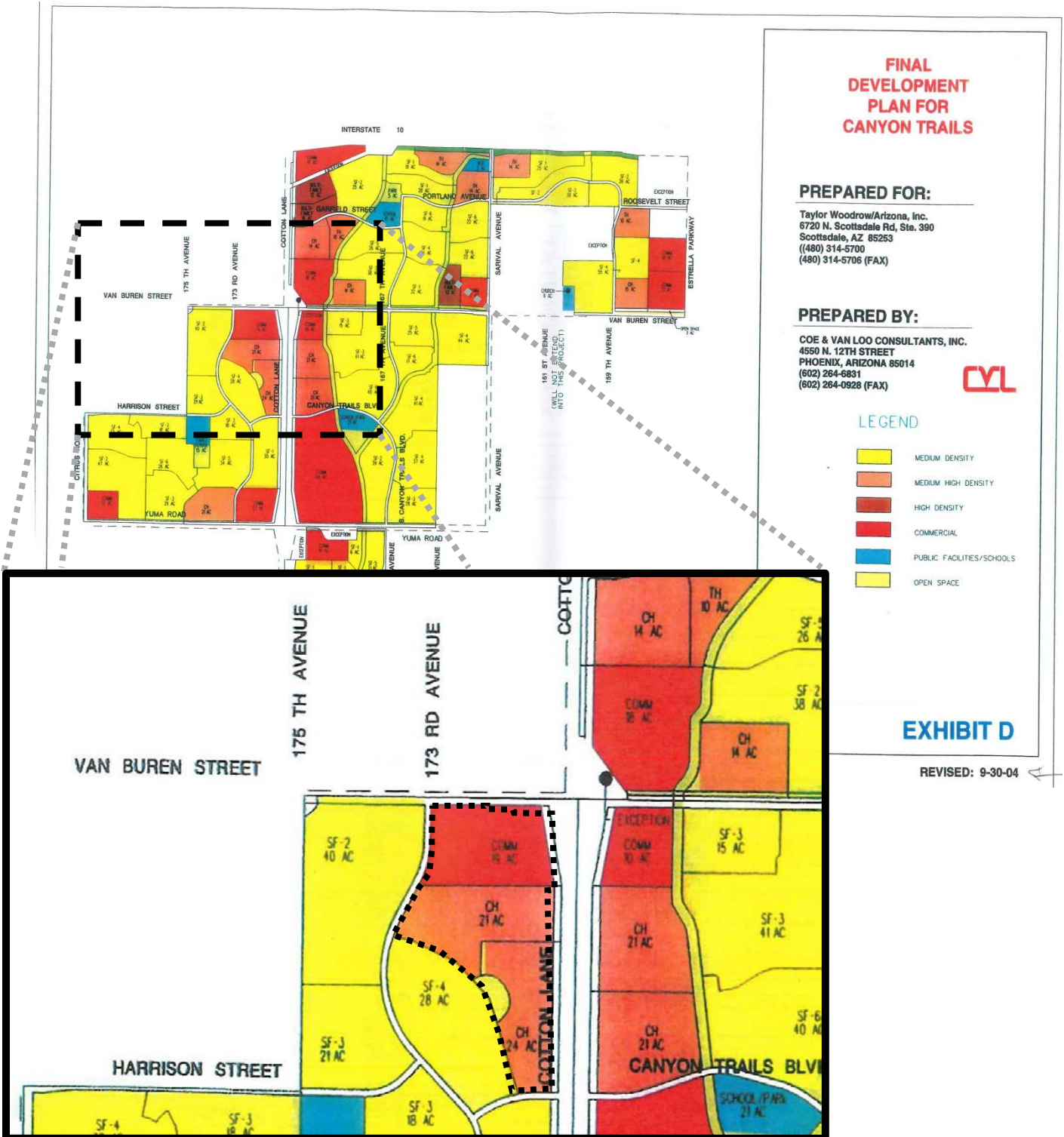

Exhibit D
Existing Zoning
(Canyon Trails PAD Land Use Plan)



**FINAL
DEVELOPMENT
PLAN FOR
CANYON TRAILS**

PREPARED FOR:

Taylor Woodrow/Arizona, Inc.
6720 N. Scottsdale Rd, Ste. 390
Scottsdale, AZ 85253
(480) 314-5700
(480) 314-5706 (FAX)

PREPARED BY:

COE & VAN LOO CONSULTANTS, INC.
4550 N. 12TH STREET
PHOENIX, ARIZONA 85014
(602) 264-6831
(602) 264-0926 (FAX)



LEGEND

- MEDIUM DENSITY
- MEDIUM HIGH DENSITY
- HIGH DENSITY
- COMMERCIAL
- PUBLIC FACILITIES/SCHOOLS
- OPEN SPACE

EXHIBIT D

REVISED: 9-30-04

Exhibit E

Hancock Communities at Canyon Trails PAD

FINAL PAD Development Regulations

(Starts On Following Page)

Hancock Communities at Canyon Trails PAD (Case #19-210-00006)

FINAL PAD Development Regulations

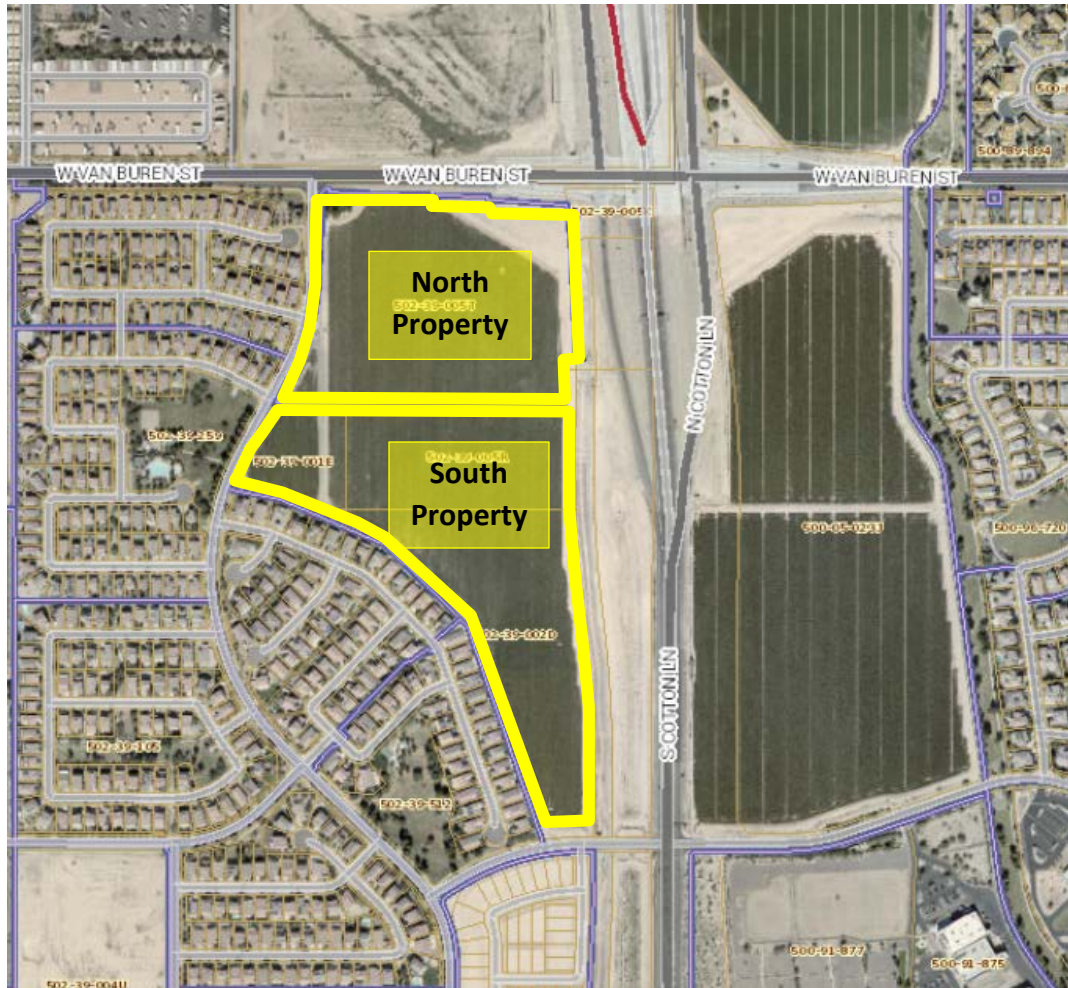

Unless otherwise modified below, development within the Hancock Communities at Canyon Trails project, including the North Property originally known as Christopher Todd Communities at Canyon Trails (zoned with cases #18-210-00001 & #19-210-00002) and the South Property (added the PAD with case #19-210-00006) shall comply with the applicable standards contained with the City of Goodyear Zoning Ordinance for Multi-Family, specifically MF-18.

Primary and Accessory uses on the property shall be those permitted within the MF-18 district.

Development Standard	Hancock at Canyon Trails Development Regulations (Modifications to MF-18 Zoning are noted in bold)
Maximum Density (dwelling units per net acre)	14 du/ac
Maximum Height (Primary and Accessory buildings)	20 ft./1 story for residential primary buildings 20 ft./1 story for residential accessory buildings (office, fitness center, etc.) ⁽¹⁾

Hancock Communities at Canyon Trails PAD (Case #19-210-00006)

FINAL PAD Development Regulations

Development Standard	Hancock at Canyon Trails Development Regulations (Modifications to MF-18 Zoning are noted in bold)
Minimum Building Setbacks (Perimeter)	
Front (173 rd Avenue)	30 ft.
Street Side (Van Buren)	20 ft.
Side (south)	20 ft.
Rear (Loop 303/ MCFCD)	20 ft.
Min. Separation Between Buildings (1-story)	10 ft.
Max. Building Coverage	50%
Min. Recreational Open Space (sq. ft./unit)	400
Minimum Perimeter Landscape/Open Space Setbacks	
Front (173 rd Avenue)	15 ft. ⁽²⁾
Street Side (Van Buren)	10 ft. ⁽³⁾
Side (south)	0 ft. ⁽⁴⁾
Rear (Loop 303/ MCFCD)	0 ft. ⁽⁴⁾

- (1) If a vehicular entry portico is provided, a sufficient height of 30 feet shall be allowed for emergency vehicle ingress and egress as well as appropriate architectural rooflines to match the primary buildings.
- (2) Adjacent to the required 15' landscape tract outside of the perimeter wall along 173rd Avenue, a minimum 15' private yard shall be provided with one tree for additional separation and landscape buffering.
- (3) Adjacent to the required 10' landscape tract outside of the perimeter wall along Van Buren Road, a minimum 14' private yard shall be provided with one tree for additional separation and landscape buffering.
- (4) In lieu of a separate landscape buffer, minimum 20' private yards shall be provided adjacent to the property line with one tree in each yard to serve as the separation and landscape buffering.

Design Guidelines

All development within the Hancock Communities at Canyon Trails PAD shall exhibit enhanced building elevations with a variety of materials and paint colors to avoid the look of sameness. Architecture theme for the community shall be in general conformance with the conceptual elevations of "Santa Barbara" and "Tuscan", dated December 6, 2019 and attached herein. A minimum of three color schemes shall be used for each theme to add variety and visual interest with exterior colors and materials specific to each color scheme. Each one-story residence will feature four-sided detailing including but not limited to masonry or stone, corbels, column details, and gable end detailing, appropriate for the architectural theme. The massing of the structures will include articulated facades, varying roof forms which will include tile covered roofs featuring hipped gables, Dutch gables, and dormers typical of the architecture style. Flat roofs will not be permitted.

Santa Barbara Theme Conceptual Elevations

12-6-2019



Tuscan Theme Conceptual Elevations

12-6-2019

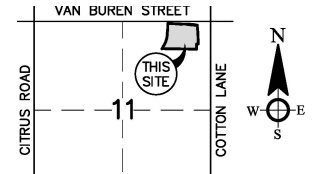

Exhibit F
Hancock Communities at Canyon Trails PAD
Conceptual Site Plans

(On following page)

HANCOCK COMMUNITIES AT CANYON TRAILS NORTH

A PORTION OF THE NORTHEAST QUARTER OF SECTION 11, TOWNSHIP 1 NORTH, RANGE 2 WEST OF THE GILA AND SALE RIVER MERIDIAN, MARICOPA COUNTY, ARIZONA



SITE PLAN YIELD

GROSS AREA ±962,816 SF / ±22.10 AC
 NET AREA ±847,600 SF / ±19.46 AC
 DENSITY PROVIDED 261 UNITS/22.10 AC=11.81 DU/AC GROSS AC
 261 UNITS/19.46 AC=13.41 DU/AC NET AC

PROJECT DESCRIPTION

CASITA 2-BEDROOM AND DUPLEX 1-BEDROOM SINGLE STORY RENTAL PROPERTY

PROJECT DATA

UNIT TYPE	YIELD	TOTAL # BEDS	UNIT SQUARE FEET	TOTAL SQUARE FEET	MIX %
1 BEDROOM	108	108	640.84	69,211	41
2 BEDROOM	153	306	997.37	152,598	59
UNITS PROVIDED	261	414		221,808	100
RENTAL OFFICE				1,162	
FITNESS CENTER				2,178	
GARAGES				5,400	
TOTAL:				230,548	

KEY NOTES

- REFUSE CONTAINER AREA PER C.O.G. STD DET G-3162-1 & G-3164-1
- PROPOSED COVERED PARKING (TYP)
- 28' INSIDE RADIUS, 48' OUTSIDE RADIUS
- MAIL BOX LOCATION
- (2) ONE BEDROOM UNITS
- TWO BEDROOM UNIT
- PRIVATE BACKYARDS W/ACCESS THROUGH GATES
- 6" CURB AND GUTTER W/DEPRESSED LIP (TYP)
- PROPOSED FIRE HYDRANT
- MULTI-UNIT COURTYARD. SEE LANDSCAPE PLANS FOR DETAILS (TYP). NOTE: ALL PEDESTRIAN ACCESS ARE LIGHTED
- 6' PERIMETER BLOCK WALL. SEE LANDSCAPE PLANS FOR DETAILS & MATERIALS.
- A/C UNIT (TYP) IN REAR YARDS
- SITE VISIBILITY TRIANGLE PER C.O.G. STD DET G-3232
- POOL COMPLEX/LEASING OFFICE
- KEY SMPPE
- SITE MAP MONUMENT
- INGRESS/EGRESS GATE
- ENTRY MONUMENT
- ENTRY PORTICO. 14" MINIMUM CLEARANCE IN DRIVE AISLES. SEE BUILDING ARCHITECT PLANS FOR DETAIL & ELEVATION
- REAR YARD WALL (TYP). SEE LANDSCAPE PLANS FOR DETAILS
- ASPHALT
- OPEN SPACE GRASS AMENITY AREA
- STAMPED ASPHALT AT ENTRY THROAT
- PRIMARY PROJECT ENTRY
- FLAG POLE
- EGRESS GATES

LEGEND

- RIGHT OF WAY LINE
- BOUNDARY LINE
- STREET CENTERLINE
- ACCESSIBLE ROUTE
- EX WATERLINE
- EX GAS LINE
- EX SEWER LINE
- EX LIGHT POLE
- EX STORM DRAIN MANHOLE
- EX FIRE HYDRANT
- EX WATER VALVE
- EX WATER MANHOLE
- EX SEWER MANHOLE
- EX IRRIGATION MANHOLE
- EX WATER METER
- ONE BEDROOM
- TWO BEDROOM
- GARAGE PARKING
- HANDICAP PARKING

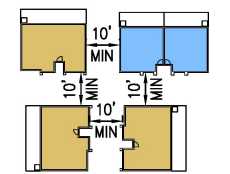

TYPICAL BUILDING SPACING NTS

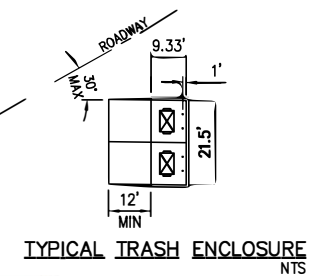

TYPICAL TRASH ENCLOSURE NTS

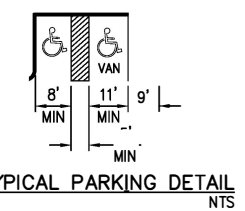

TYPICAL PARKING DETAIL NTS

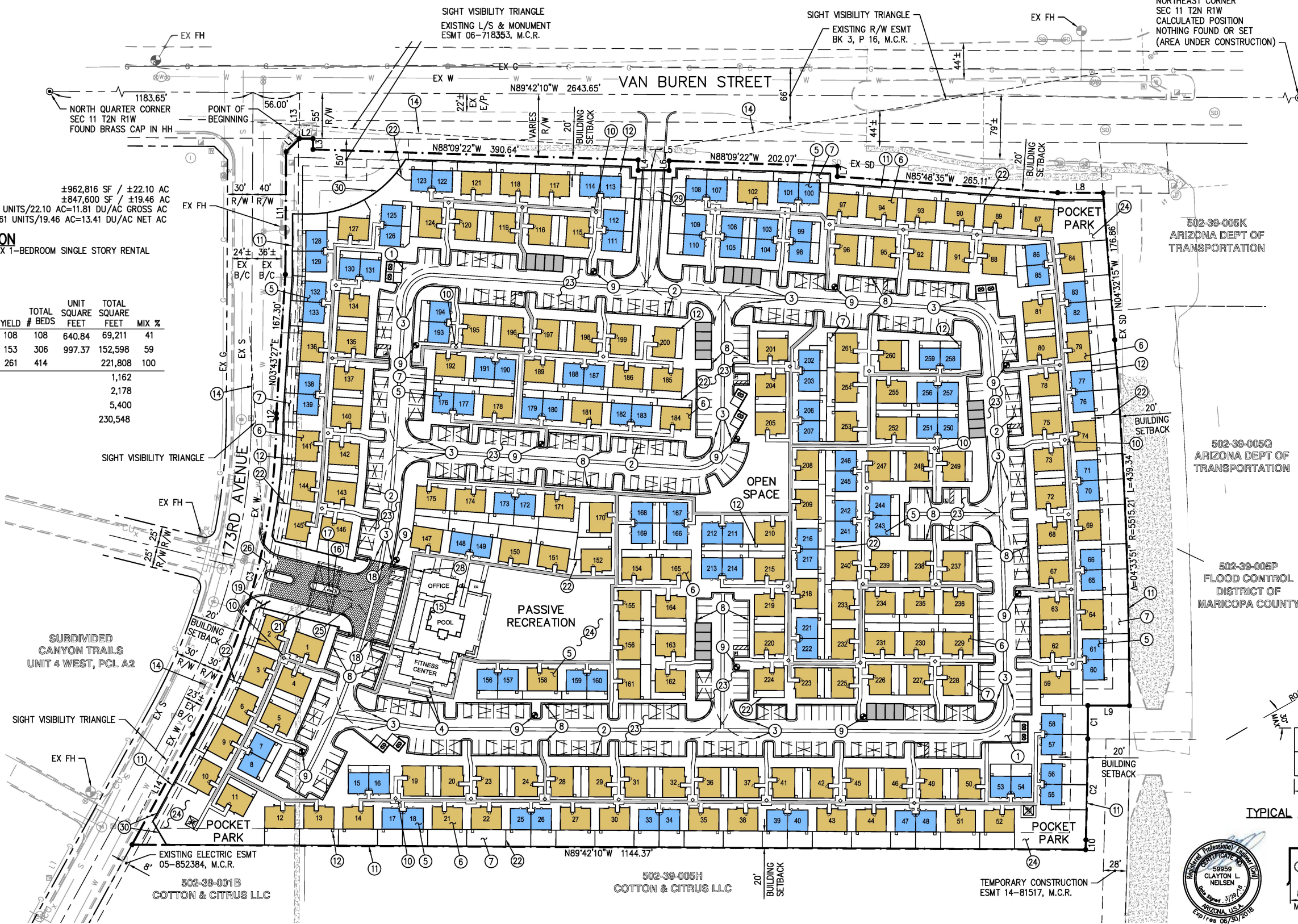

CONCEPTUAL SITE PLAN

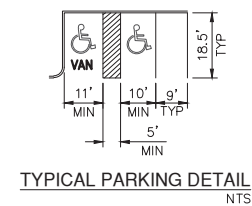
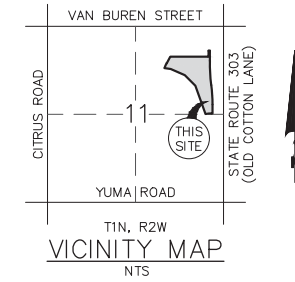
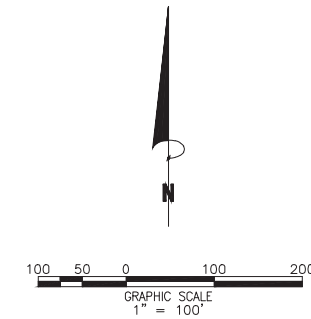
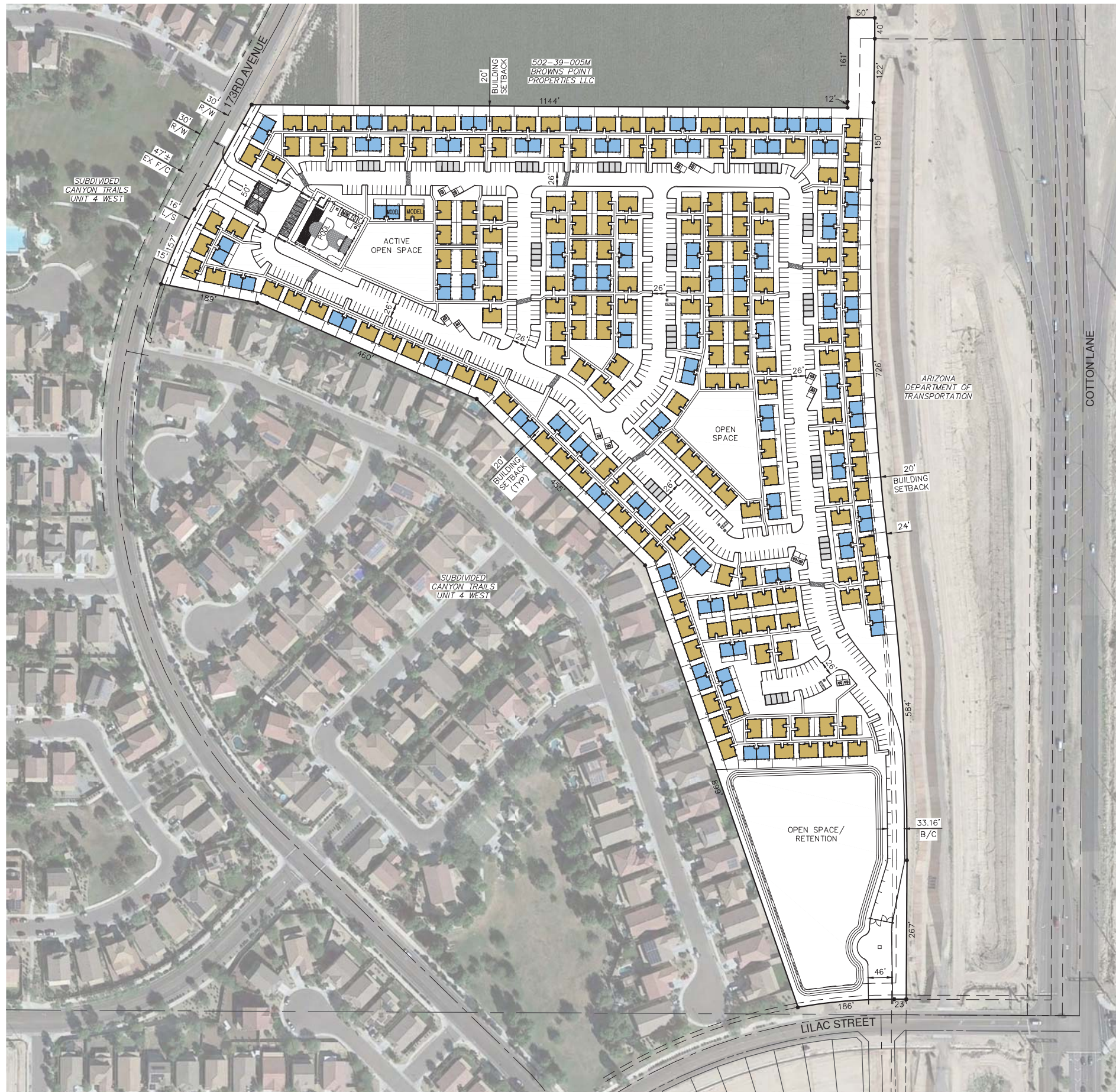

MULTI-FAMILY UNITS AND PARKING				
	NUMBER OF UNITS	MIX %	PARKING REQUIRED PER UNIT	TOTAL PARKING REQUIRED
1 BEDROOM	120	41%	1.5	180
2 BEDROOM	175	59%	2.0	350
TOTALS	295	100%		530
VISITOR PARKING REQ (1/10)				30
TOTAL PARKING REQUIRED				560
			PARKING PROVIDED	578

NOTE: 1. PARKING PROVIDED INCLUDES GARAGES
2. UNIT COUNT INCLUDES OFFICE AND MODELS

SITE DATA	
GROSS ACRES	27.11
NET ACRES	26.70
GROSS DU/AC	10.88
NET DU/AC	11.05

ACREAGE	
NET - OVERALL	26.70
RETENTION AREA	2.14
NET USABLE	24.10

Bowman
CONSULTING

Bowman Consulting Group, Ltd.
1285 West Washington, Ste 108
Tempe, Arizona 85281
Phone: (480) 629-8830
www.bowmanconsulting.com
© Bowman Consulting Group, Ltd.

CONTEXT PLAN
CANYON TRAILS SOUTH
MARICOPA COUNTY
GOODYEAR, AZ

PROJECT NUMBER

PLAN STATUS

DATE	DESCRIPTION		
DAB	DAB	BPL	
DESIGN	DRAWN	CHKD	
SCALE	H:	V:	
JOB No.	050605-01-014		
DATE :	7/30/2019		

1
SHEET 1 OF 1

HANCOCK
COMMUNITIES

Exhibit G

Hancock Communities at Canyon Trails PAD

Conceptual Landscape Plans

(On following page)

PLANT LEGEND

SYMBOL	BOTANICAL NAME	COMMON NAME
SMALL TREES 	<i>Acacia aneura</i> <i>Bauhinia blakeana</i> <i>Caesalpinia Mexicana</i> <i>Pistacia lentiscus</i>	Mulga Hongkong Orchid Tree Mexican Bird of Paradise Mastic Tree
MEDIUM TREES 	* <i>Acacia willardiana</i> * <i>Chilopsis linearis</i> 'Bubba' * <i>Cercidium X Desert Museum</i> <i>Phoenix dactylifera</i>	Palo Blanco Desert Willow-Bubba Desert Museum Palo Verde Date Palm
LARGE TREES 	<i>Acacia salicina</i> * <i>Pistacea Chinensis</i> 'RED PUSH' <i>Tipuana tipu</i> * <i>Quercus virginiana</i> <i>Ulmus parvifolia sempervirens</i>	Willow Acacia Red Push Pistache Tipu Tree Southern Live Oak Chinese Evergreen Elm
SMALL SHRUBS 	<i>Eremophila hygrophana</i> <i>Pittosporum tobira</i> 'Wheeler's dwarf' <i>Ruellia brittoniana</i>	Blue Bells Wheeler's Dwarf Mock Orange British Ruellia
MEDIUM SHRUBS 	<i>Callistemon 'Little John'</i> <i>Eremophila maculata</i> <i>Justicia spicigera</i> <i>Nerium oleander</i> 'Petite Salmon'	Little John Dwarf Bottlebrush Valentine Bush Mexican Honeysuckle Petite Salmon Oleander
LARGE SHRUBS 	<i>Leucophyllum frutescens</i> 'Green Cloud' <i>Tacoma x 'Sunrise'</i> <i>Dodonea viscosa</i>	Green Cloud Sunrise Tecoma Hopbush
ACCENTS 	<i>Agave desmettiana</i> <i>Aloe barbadensis</i> <i>Hesperaloe 'Pink Parade'</i> <i>Dietes bicolor</i> <i>Dasyliroton quadrangulatum</i> <i>Hesperaloe parviflora</i> <i>Russelia equisetiformis</i> <i>Chamaerops humilis</i>	Smooth Agave Medicinal Aloe Pink Parade Yucca Fortnight Lily Toothless Spoon Brake Lights Yucca Coral Fountain Mediterranean Fan Palm
SMALL GROUND COVERS 	<i>Dalea capitata</i> <i>Lantana camara</i> 'New Gold' <i>Carrisa macrocarpa</i> 'Green Carpet'	Lemon Dalea New Gold Lantana Green Carpet
LARGE GROUND COVERS 	<i>Eremophila glabra</i> 'Outback Sunrise'	Outback Sunrise Eremophila
	3" Screened Decomposed Granite Madison Gold	Hybrid Bermuda Turf Grass

KEY NOTES

1. THEME WALL SEE DETAIL 1 SHEET 4.
2. VIEW FENCE WALL SEE DETAIL 4, SHEET 4.
3. PERIMETER WALL SEE DETAIL 2 SHEET 4.
4. 8' H SOUND PERIMETER WALL PER SITE PLAN DETAIL PREPARED BY BOWMAN ENGINEERING.
5. TYPICAL FRONTAGE LANDSCAPE SEE ENLARGEMENT PLAN SHEET 3.

NOTE:
ALL PLANTINGS TO BE IRRIGATED BY AN AUTOMATED UNDERGROUND IRRIGATION SYSTEM.

LANDSCAPE STRIP BETWEEN BACK OF CURB AND SIDEWALK SHALL CONTAIN ONE TREE PER EVERY 23 FEET ALONG 173RD AVE.

LANDSCAPE STRIP BETWEEN BACK OF CURB AND SIDEWALK SHALL CONTAIN ONE TREE PER EVERY 60 FEET ALONG VAN BUREN ST.

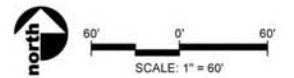

PLANT LEGEND

SYMBOL	BOTANICAL NAME	COMMON NAME
SMALL TREES		
	<i>Acacia aneura</i> <i>Bauhinia blakeana</i> <i>Caesalpinia Mexicana</i> <i>Pistacia lentiscus</i>	Mulga Hongkong Orchid Tree Mexican Bird of Paradise Mastic Tree
MEDIUM TREES		
	* <i>Acacia willardiana</i> * <i>Chilopsis linearis</i> "Bubba" * <i>Cercidium X Desert Museum</i> <i>Phoenix dactylifera</i>	Palo Blanco Desert Willow-Bubba Desert Museum Palo Verde Date Palm
LARGE TREES		
	<i>Acacia salicina</i> * <i>Pistacea Chinensis</i> "RED PUSH" <i>Tipuana tipu</i> * <i>Quercus virginiana</i> <i>Ulmus parvifolia</i> <i>sempervirens</i>	Willow Acacia Red Push Pistache Tipu Tree Southern Live Oak Chinese Evergreen Elm
SMALL SHRUBS		
	<i>Eremophila</i> <i>hygrophana</i> <i>Pittosporum tobira</i> "Wheelers dwarf" <i>Ruellia brittoniana</i>	Blue Bells Wheelers Dwarf Mock Orange British Ruellia
MEDIUM SHRUBS		
	<i>Callistemon 'Little John'</i> <i>Eremophila maculata</i> <i>Justicia spicigera</i> <i>Nerium oleander</i> "Petite Salmon"	Little John Dwarf Bottlebrush Valentine Bush Mexican Honeysuckle Petite Salmon Oleander
LARGE SHRUBS		
	<i>Leucophyllum frutescens</i> "Green Cloud" <i>Tacoma x 'Sunrise'</i> <i>Dodonea viscosa</i>	Green Cloud Sunrise Tecoma Hopbush
ACCENTS		
	<i>Agave desmettiana</i> <i>Aloe barbadensis</i> <i>Hesperaloe 'Pink Parade'</i> <i>Diets bicolor</i> <i>Dasyliiron quadrangulatum</i> <i>Hesperaloe parviflora</i> <i>Russelia equisetiformis</i> <i>Chamaerops humilis</i>	Smooth Agave Medicinal Aloe Pink Parade Yucca Fortnight Lily Toothless Spoon Brake Lights Yucca Coral Fountain Mediterranean Fan Palm
SMALL GROUND COVERS		
	<i>Dalea capitata</i> <i>Lantana camara</i> "New Gold" <i>Carrisa macrocarpa</i> "Green Carpet"	Lemon Dalea New Gold Lantana Green Carpet
LARGE GROUND COVERS		
	<i>Eremophila glabra</i> "Outback Sunrise"	Outback Sunrise Eremophila
	Screened Decomposed Granite Madison Gold Hybrid Bermuda Turf Grass	

NOTE:
ALL PLANTINGS TO BE IRRIGATED BY AN AUTOMATED UNDERGROUND IRRIGATION SYSTEM.



KEY NOTES

1. THEME WALL SEE DETAIL 1 SHEET 4.
2. VIEW FENCE WALL SEE DETAIL 4, SHEET 4.
3. PERIMETER WALL SEE DETAIL 2 SHEET 4.
4. 8' H SOUND PERIMETER WALL PER SITE PLAN DETAIL PREPARED BY BOWMAN ENGINEERING.
5. TYPICAL FRONTAGE LANDSCAPE SEE ENLARGEMENT PLAN SHEET 3.



WestLand Resources
2020 N. Central Avenue
Suite 695
Phoenix, Arizona 85004
(602) 888-7000

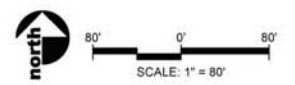

**HANCOCK COMMUNITIES
AT CANYON TRAILS
PRELIMINARY LANDSCAPE PLAN**



1 LANDSCAPE ALONG 173RD AVENUE SEE SHEET 3 FOR WALL DETAILS
SCALE: 1" = 40'



2 LANDSCAPE ALONG VAN BUREN STREET SEE SHEET 3 FOR WALL DETAILS
SCALE: 1" = 40'



- KEY NOTES** #
1. NEW 8' SIDEWALK
 2. NEW SHADE TREES
 3. SHRUBS AND GROUND COVER PLANTS
 4. TREES IN UNIT BACKYARDS
 5. 6' SCREEN WALL
 6. EXISTING LANDSCAPE TO REMAIN

AREAS OF ENLARGEMENT



NTS

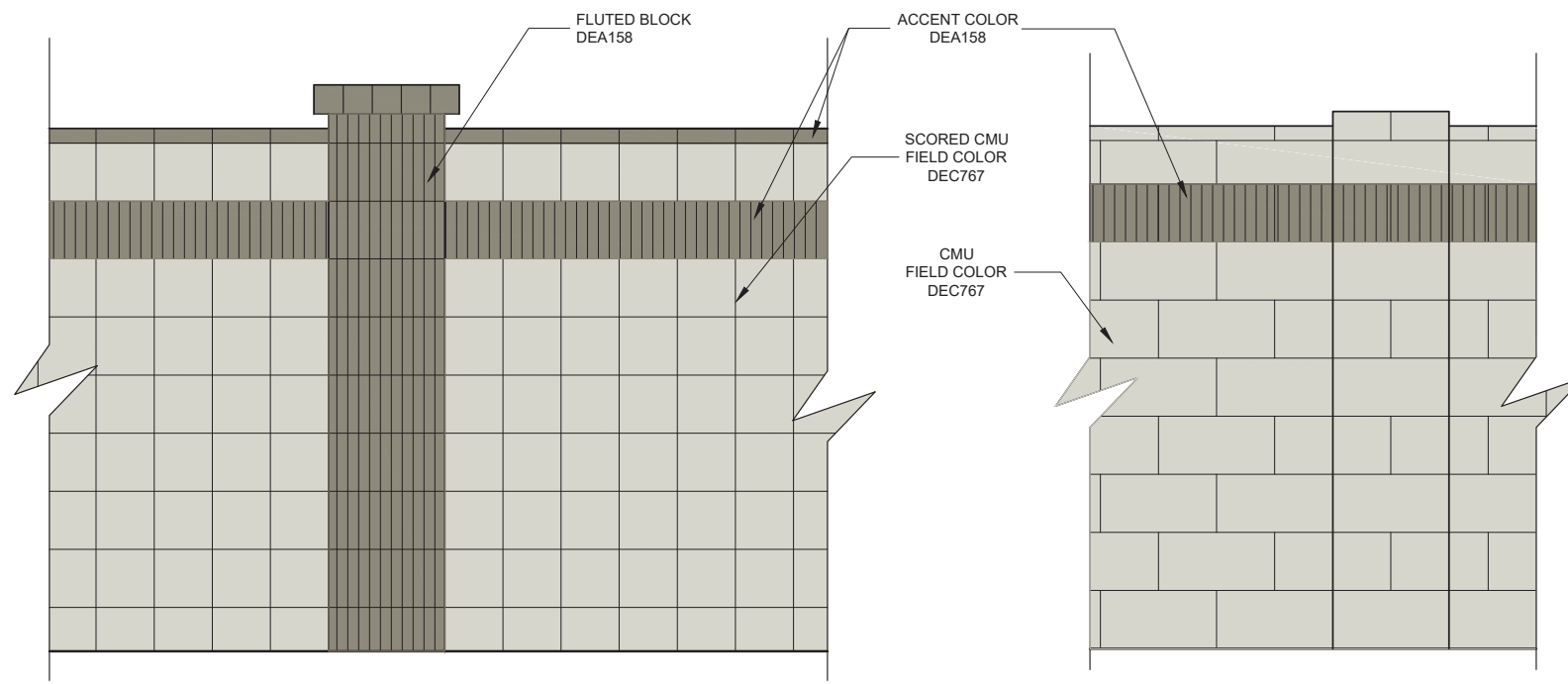

1 ELEVATION: THEME WALL & THEME PIER
SCALE: 1" = 1'-0"

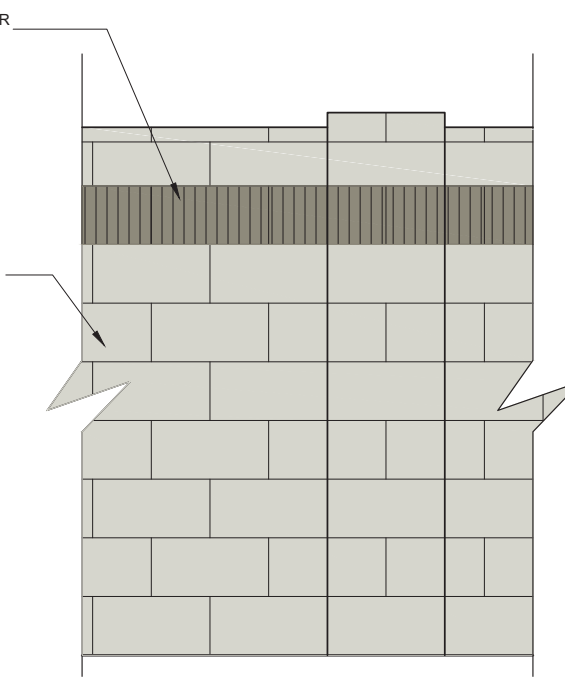

2 ELEVATION: PERIMETER WALL & PIERS
SCALE: 1" = 1'-0"

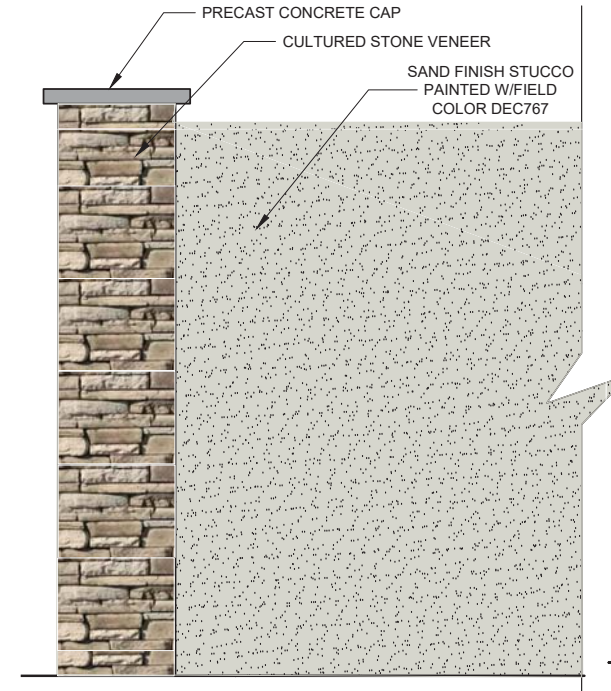

3 ELEVATION: ENTRY WALL & PIER
SCALE: 1" = 1'-0"

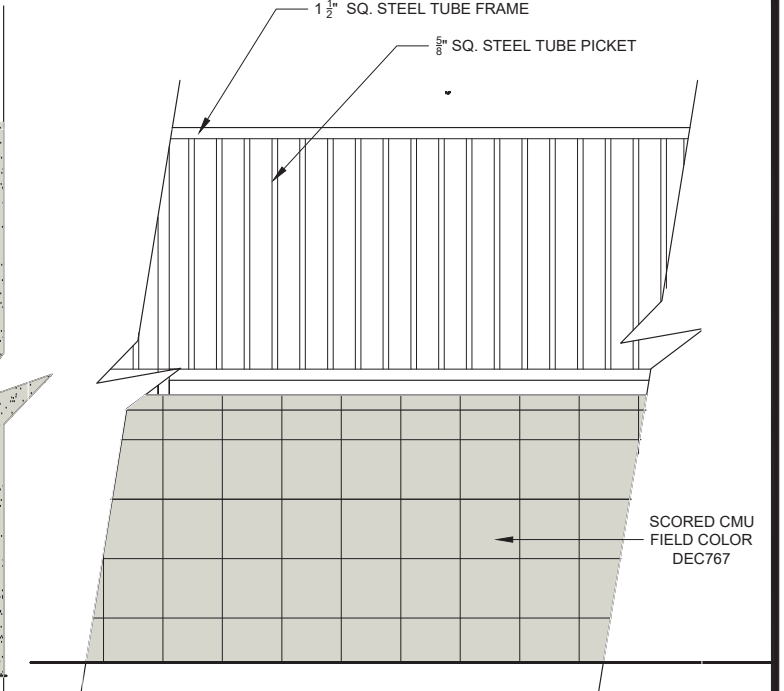

4 ELEVATION: 6' HT. VIEW FENCE
SCALE: 1" = 1'-0"

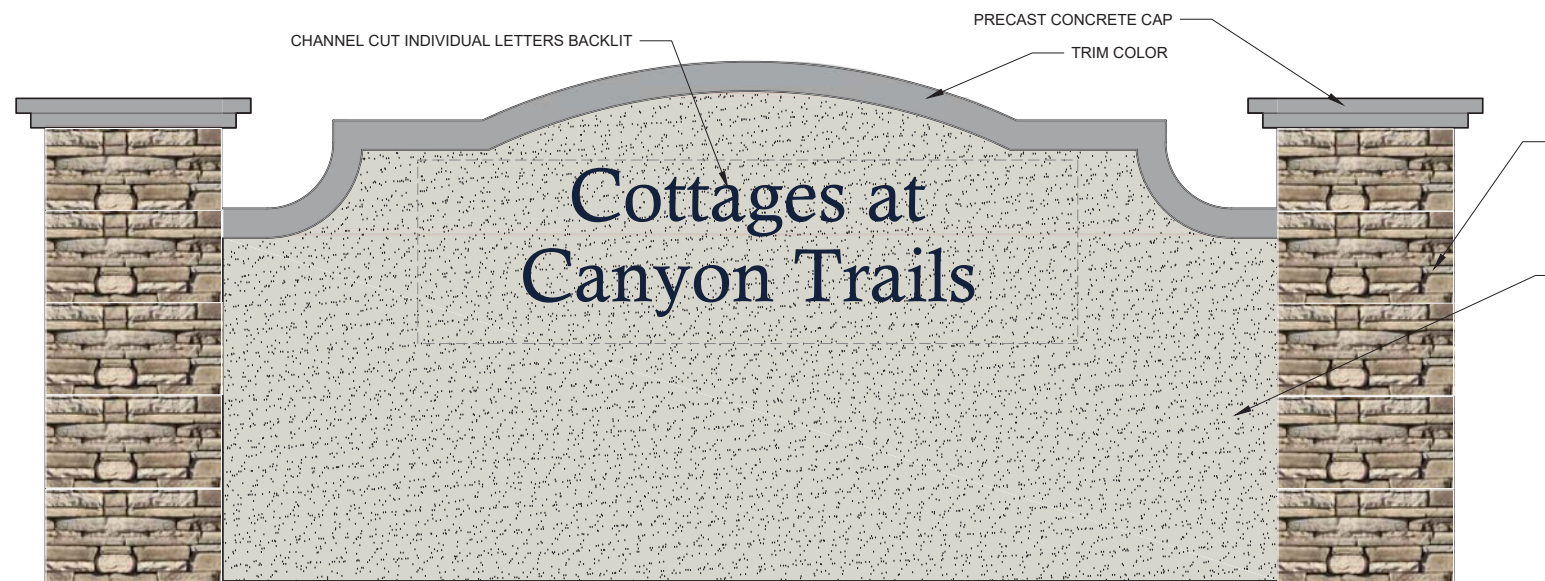

5 ELEVATION: ENTRY MONUMENT
SCALE: 1" = 1'-0"

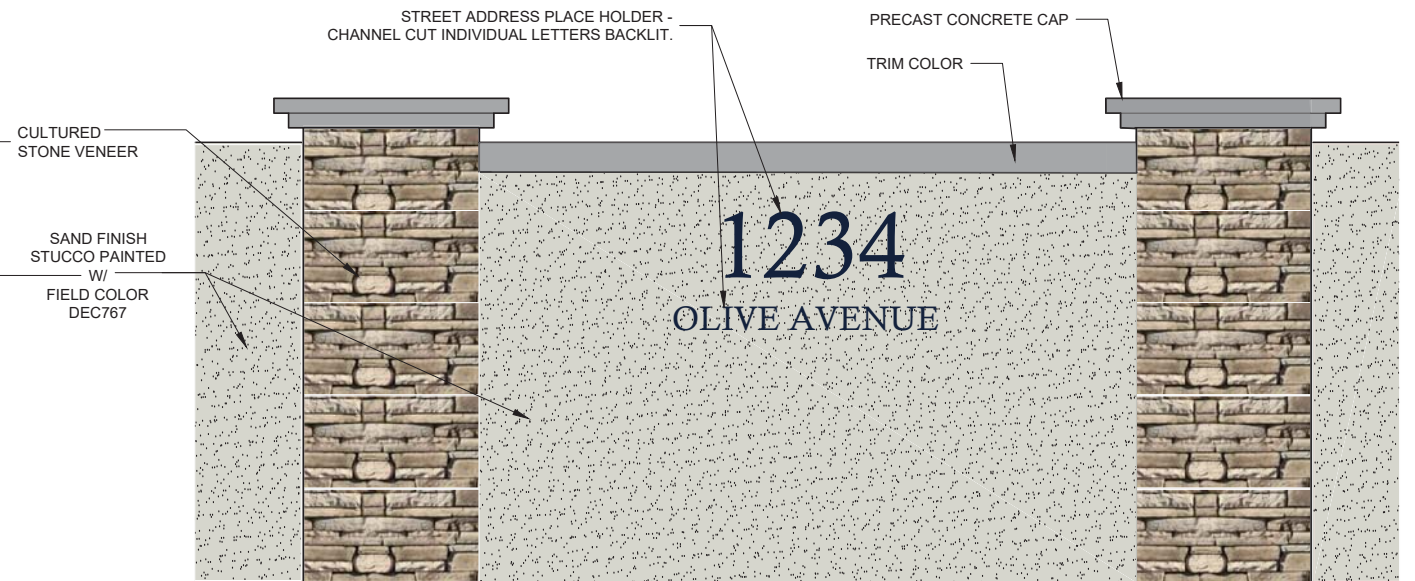

6 ELEVATION: ADDRESS ON ENTRY WALL
SCALE: 1" = 1'-0"

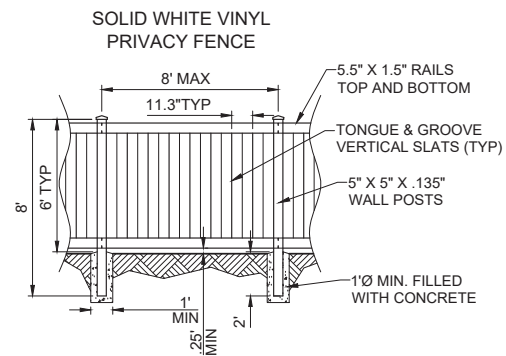
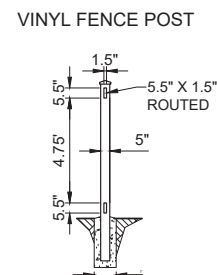
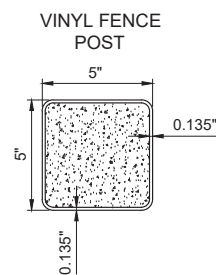

TRIM COLOR- DUNN EDWARDS MILK MUSTACHE DE6169
FIELD COLOR- DUNN EDWARDS RIVER BED DEC767
CAP COLOR- ON COLUMNS DUNN EDWARDS NORTHERN TERRITORY DEA158
STONE VANEER- CORONADO MINNESOTA FIELD STONE- DAKOTA BROWN

NOTE:

- COPY AREA FOR MONUMENT SIGNAGE WILL BE A MAXIMUM OF 32 SQ. FT.
- MONUMENT SIGNAGE WILL BE A MAXIMUM OF 8' TALL WITH UP TO 2' EXTRA FOR EMBELISHMENTS.
- BOTTOM OF SIGN COPY TO BE NO LOWER THAN 4'-MEASURED FROM STREET LEVEL (NOT TOP OF CURB)
- ADDRESS SHALL BE 9" TALL LETTERS WITH 3" STROKE AND NO LOWER THAN 3'-MEASURED FROM STREET LEVEL (NOT TOP OF CURB)

7 VINYL FENCE
SCALE: NTS

HANCOCK COMMUNITIES AT CANYON TRAILS

COMMUNITY WALLS & SIGN MONUMENT